

HENDERSON PATIO TABLE & CHAIRS WITH UMBRELLA SET

Assembly Instructions

STK #88638

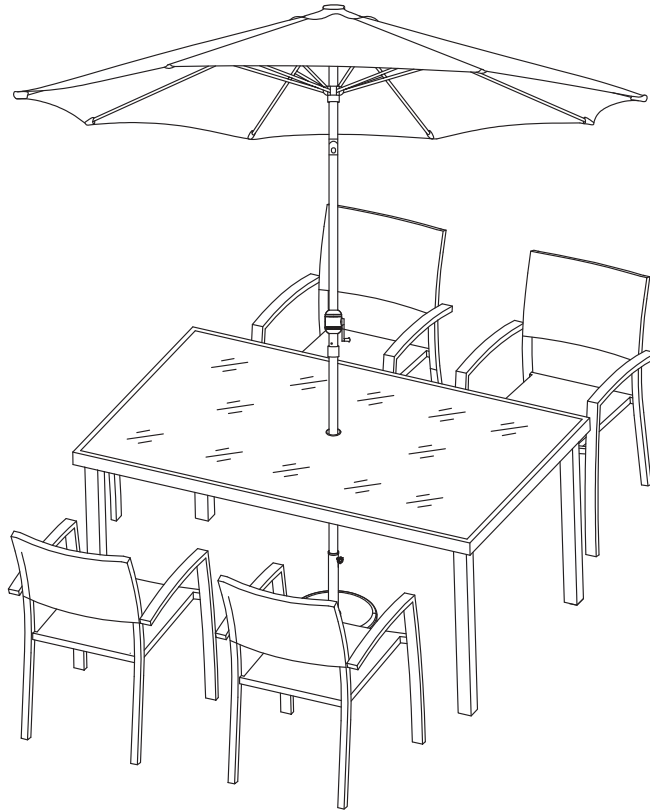

Assembly Tips

* Two adults required to assemble the product

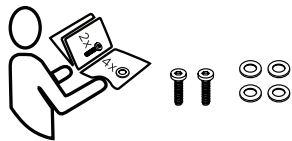

Count

all pieces and hardware before assembling.

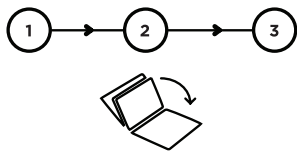

Review

the instructions from beginning to end before getting started.

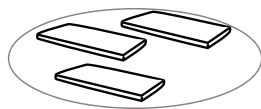

Make Space

Keep plenty of clear space and use a clean rug or drop cloth if needed.

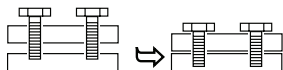







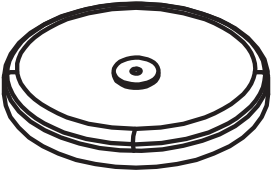

Double Check

that all pieces are in place before tightening screws. This ensures quick assembly.



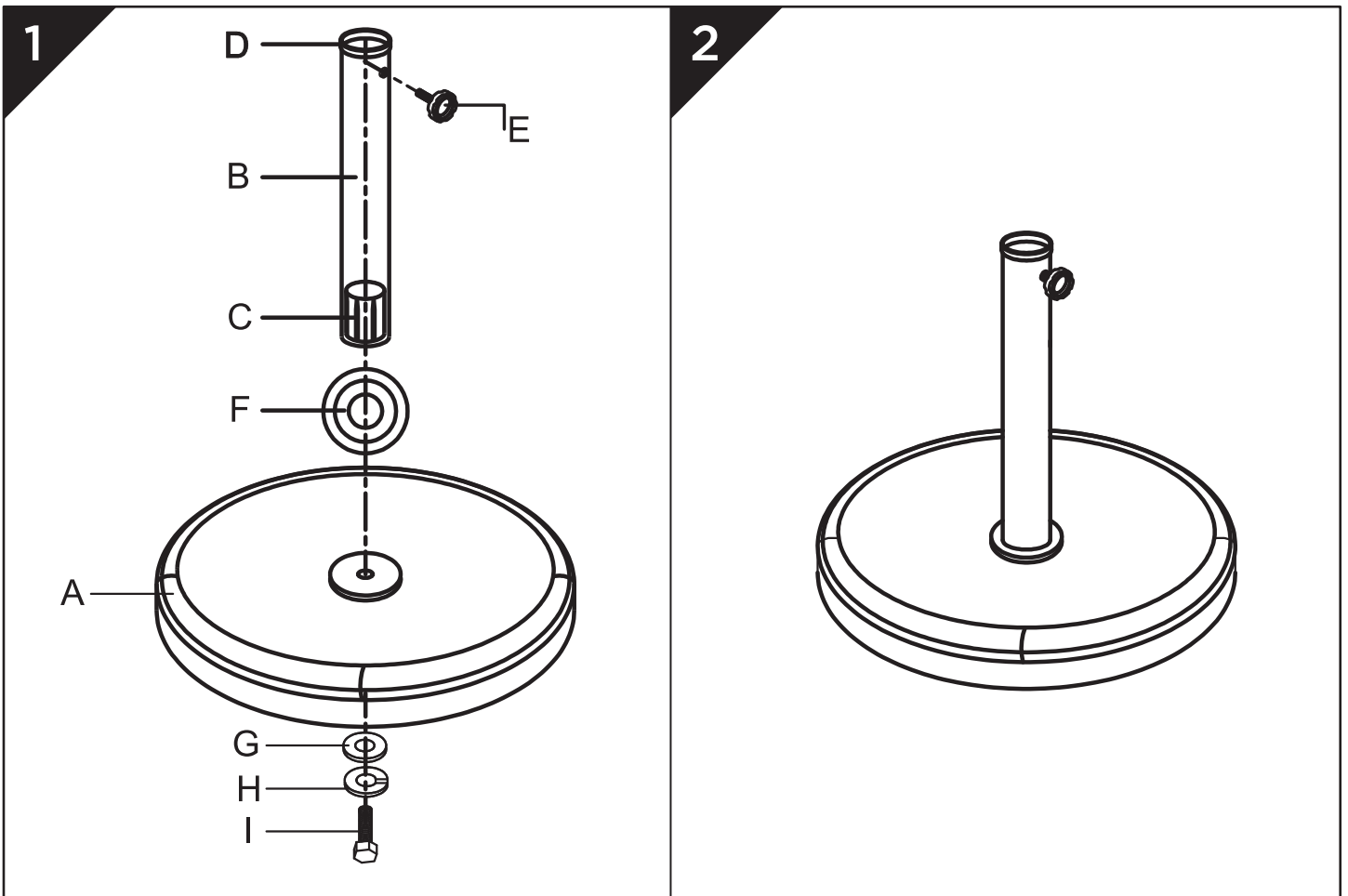

CAUTION: It is recommended to remove the umbrella from the table when not in use and during inclement weather to avoid damage and possible injury.

1. Umbrella Base Assembly Instructions

A	B	C	D	E
 <p>x 1</p>	 <p>x 1</p>	 <p>x 1</p>	 <p>x 1</p>	 <p>x 1</p>
F		G		I
 <p>x 1</p>		 <p>x 1</p>	 <p>x 1</p>	 <p>x 1</p>

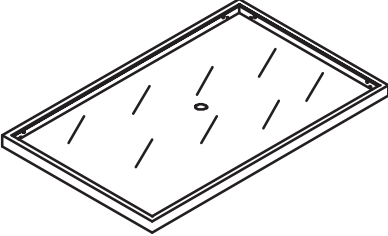
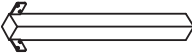
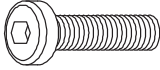

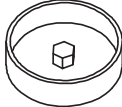
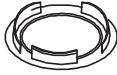
2. Table Assembly Instructions

A	B	C	D
 x 1	 x 4	 x 16	 x 16
	E	F	G
 x 16	 x 1	 x 1	

