

CABAN OUTDOOR COUCH & DINING TABLE

Assembly Instructions

STK #92631

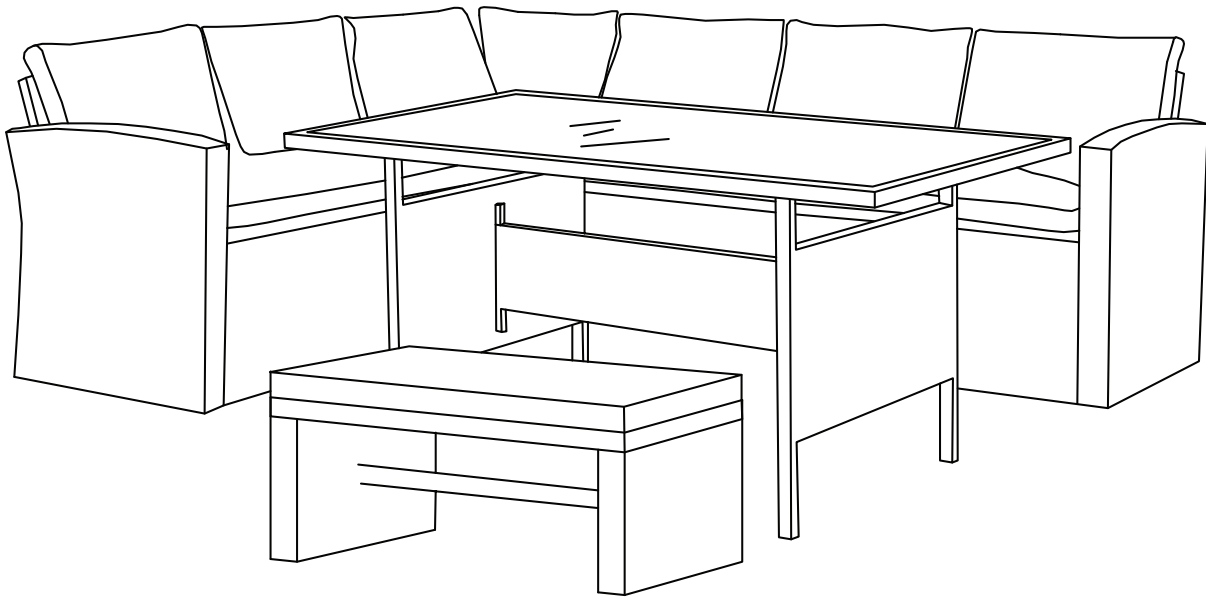

Assembly Tips

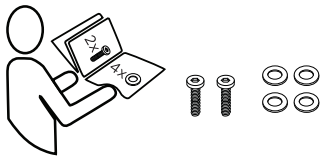

Count

all pieces and hardware before assembling.

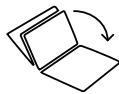
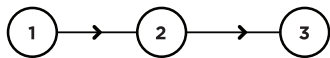

Review

the instructions from beginning to end before getting started.

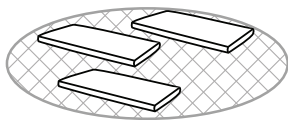

Make Space



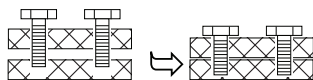

Keep plenty of clear space and use a clean rug or drop cloth if needed.

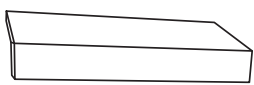
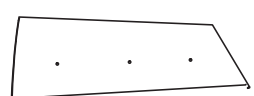
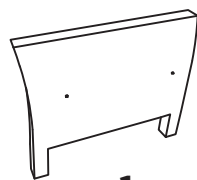
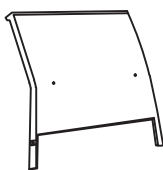
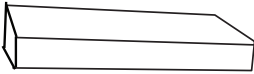
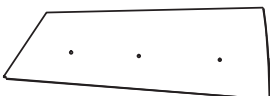
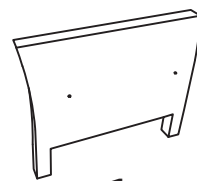
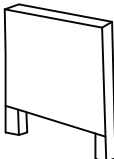
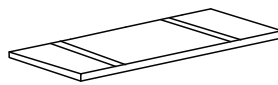

Double Check

that all pieces are in place before tightening screws. This ensures quick assembly.

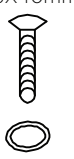
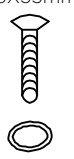
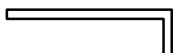
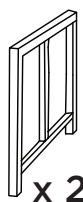
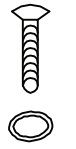
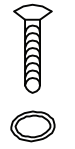
Parts Avoid using sharp objects such as a knife to cut open packing as you may accidentally damage the upholstery.

<p>A</p>  <p>x 1</p>	<p>B</p>  <p>x 1</p>	<p>C</p>  <p>x 1</p>	<p>D</p>  <p>x 1</p>
<p>E</p>  <p>x 1</p>	<p>F</p>  <p>x 1</p>	<p>G</p>  <p>x 1</p>	<p>H</p>  <p>x 2</p>
<p>I</p>  <p>x 1</p>	<p>J</p>  <p>x 1</p>	<p>K</p> <p>M6X40mm</p>  <p>x 13</p>	<p>L</p> <p>M6X35mm</p>  <p>x 15</p>
<p>O</p>  <p>x 1</p>	<p>P</p>  <p>x 2</p>	<p>M</p> <p>M6X30mm</p>  <p>x 4</p>	<p>N</p> <p>M6X20mm</p>  <p>x 8</p>
		<p>Q</p>  <p>x 1</p>	<p>R</p>  <p>x 1</p>

Bench

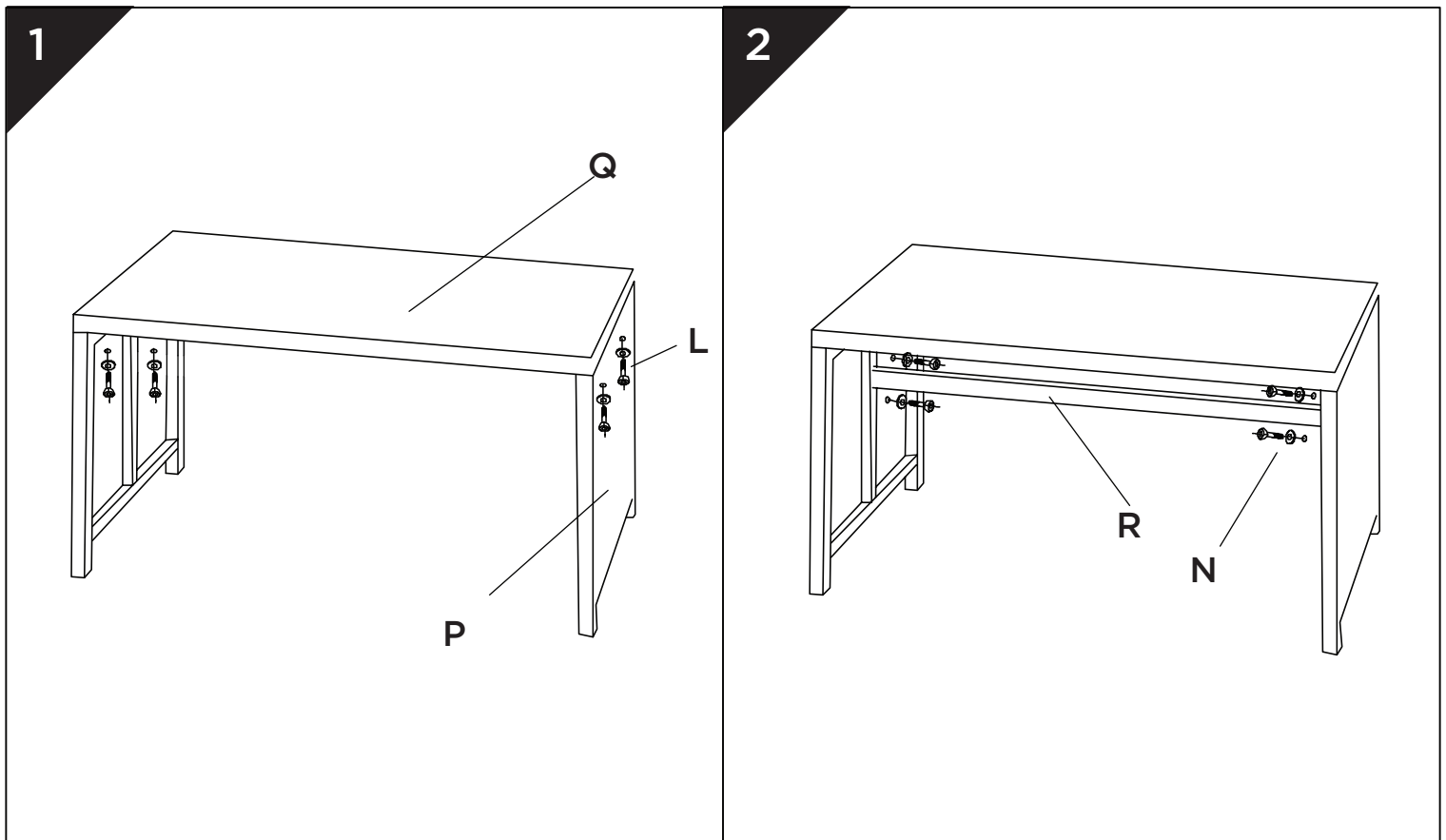

3 seat corner sofa

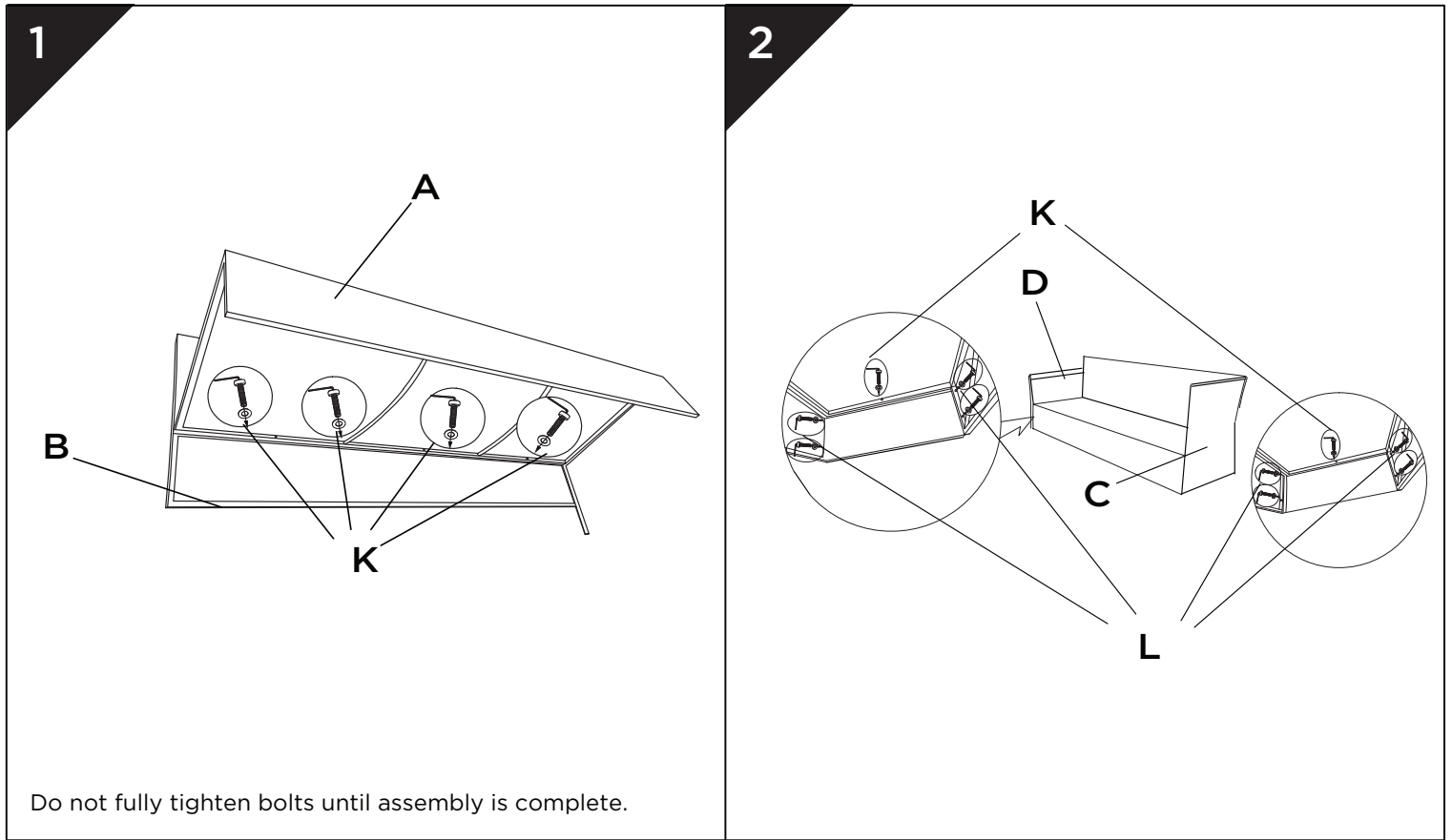

3 seat sofa

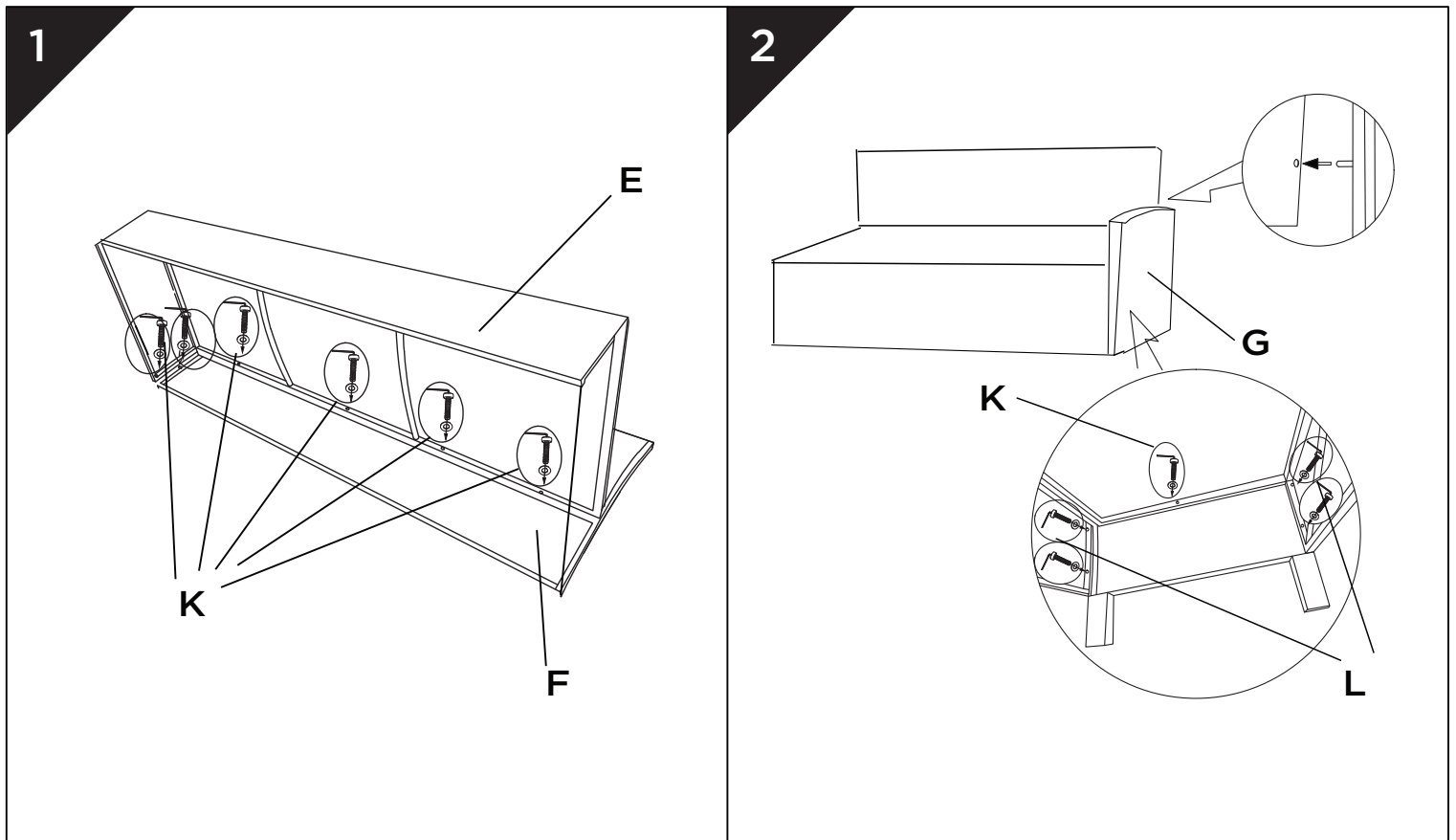

Dinning table

1

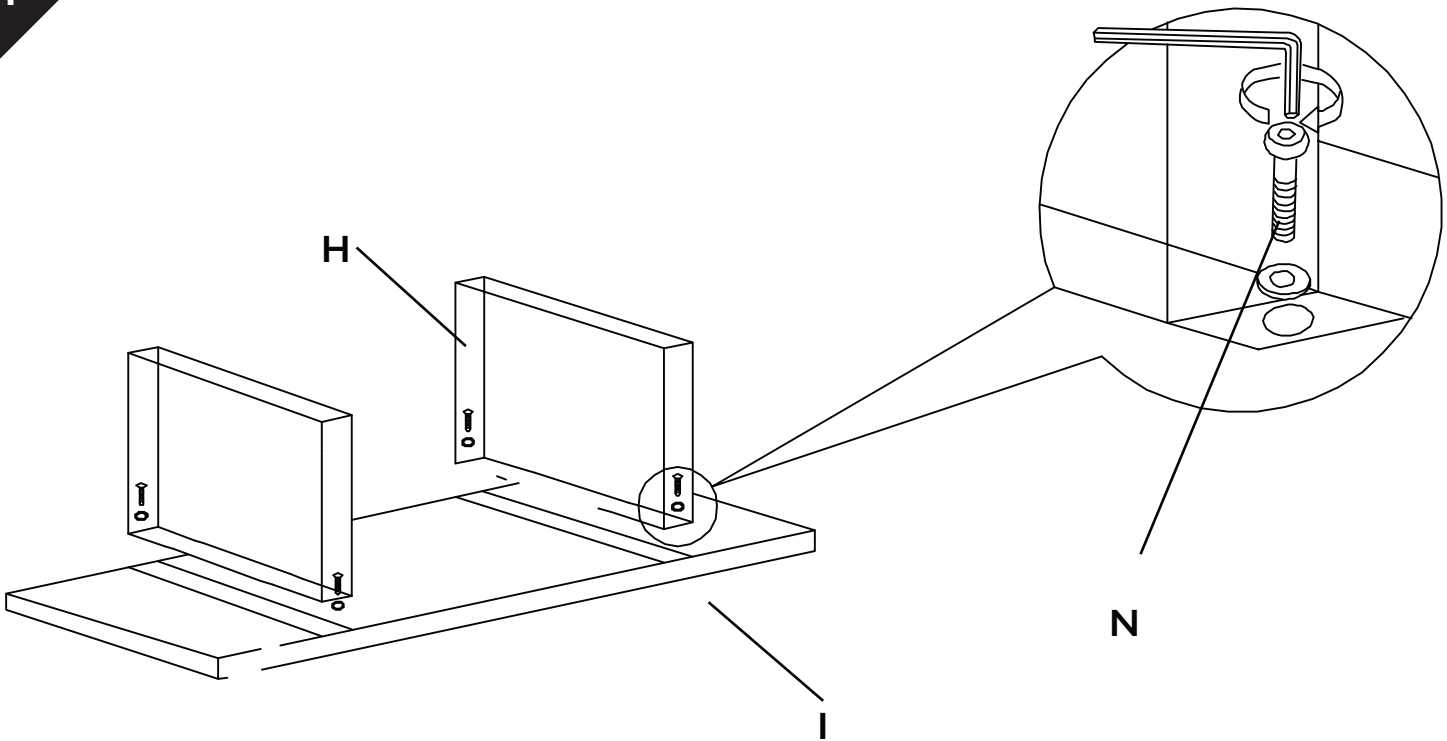

2

